

Feature:

- Designed to operate reliably in smoke control systems requiring Underwriter's Laboratories UL555S (rated at 250°F).
- Mounts easy on round & square shaft (optional).
- External clutch for manual adjustments.
- Maintenance free.
- Position indicator.
- Fail safe by *Enerdrive System*¹
- 2 auxiliary switches (only on models 080, 180 & 280)

BT060X8
BT160X8
BT260X8
BT080X8
BT180X8
BT280X8

Technical Data	BT060X8	BT160X8	BT260X8	BT080X8	BT180X8	BT280X8
Power supply	22 to 26VAC 50/60Hz or 24VDC	110 to 130 VAC 50/60Hz	220 to 250 VAC 50/60Hz	22 to 26VAC 50/60Hz or 24VDC	110 to 130 VAC 50/60Hz	220 to 250 VAC 50/60Hz
Auxiliary switches	No			2 switches rated 250VAC, 5A switching points: 5° & 85° +/-5°		
Torque	70 in.lb. [8 Nm] at rated voltage					
Fail safe - Enerdrive	Yes					
Power consumption	Running 15VA, Holding 5VA					
Control signal	2 wire / 2 position					
Running time through 90°	20 to 30 sec Torque dependant Fail safe: 15 sec. max at rated torque.					
Electrical connection	18 AWG [0.8mm ²] minimum					
Inlet bushing	2 inlet bushing of 5/8 in [15.9 mm] & 7/8 in [22.2 mm]					
Angle of rotation	0 to 90 degrees, mechanically adjustable (factory set with 90° stroke)					
Direction of rotation	Reversible, Clockwise (CW) or Counterclockwise (CCW) (factory set with CW direction)					
Ambient temperature Operation	0°F to +122°F [-18° C to +50° C] 3 cycles at +250°F [+121° C]					
Storage temperature	-22°F to +122°F [-30° C to +50° C]					
Relative Humidity	5 to 95 % non condensing.					
Enclosure type	NEMA type 2 / IP42					
Weight	3 lbs. [1.4 kg]					

Warning: Do not press the clutch when actuator is powered

Warning for BT160/260/180/280X8: High Voltage. Risk of electric chock.

Dimensions

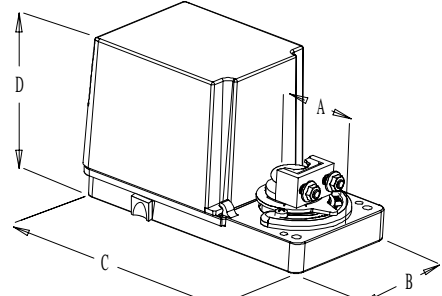

Dimension	Inches	Metric (mm)
A	1.50	38.1
B	3.26	82.8
C	6.60	167.5
D	3.72	94.5

Caution

We strongly recommend that all neptronic® products be wired to a separate transformer and that transformer shall service only neptronic® products. This precaution will prevent interference with, and/or possible damage to incompatible equipment.
When multiple actuators are wired on a single transformer, polarity must be observed. Long wiring runs create voltage drop which may affect the actuator performance.

¹ Enerdrive System U.S.A. Patent #5,278,454



Mechanical installation

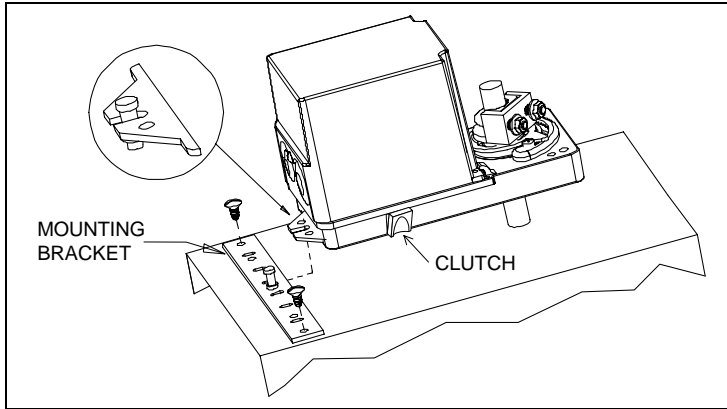

1. Manually close the damper blades and positioned the actuator at 0° or 90°.
2. Slide the actuator onto the shaft.
3. Tighten the nuts on the “U” bolt to the shaft with a 8mm wrench to a torque of 60 in.lb. [6,7 Nm].
4. Slide the mounting bracket under the actuator. Ensure free movement of the slot at the base of the actuator. The bracket pin must be placed in the mid distance of the slot.
5. Fix the bracket to the ductwork with #8 self-tapping screws.

Wiring Diagrams

Power supply - 2 wire / 2 position (ON-OFF)

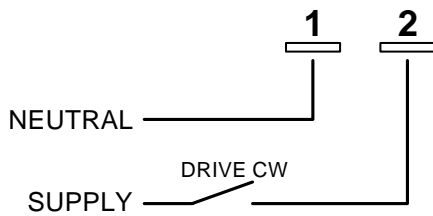

Warning for BT160/260/180/280X8:
High Voltage. Risk of electric chock.

Auxiliary switches (only on models BT080/180/280X8)

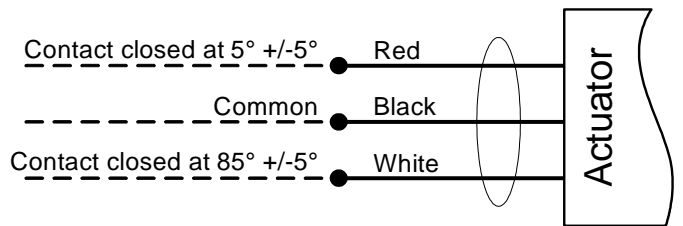

3 wire 105°C cable 18 AWG, 1 meter long

PC Board

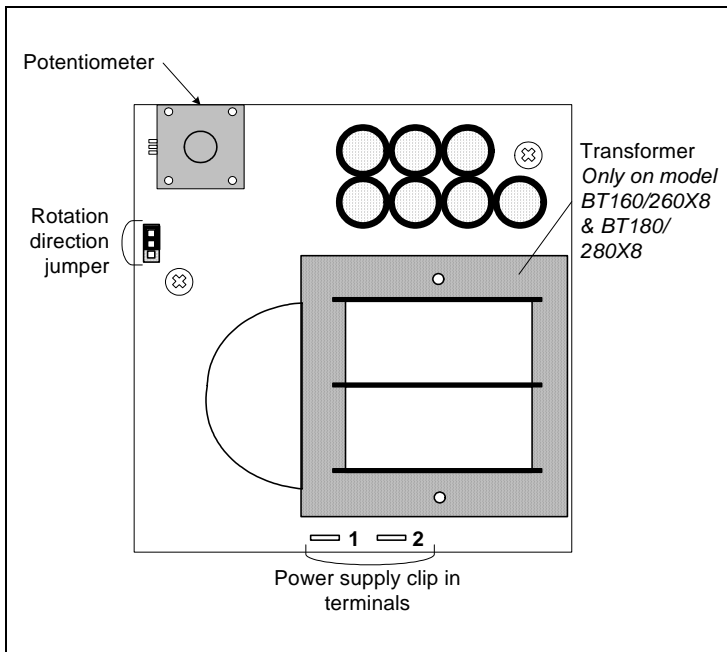

Rotation direction Jumper

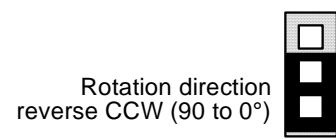
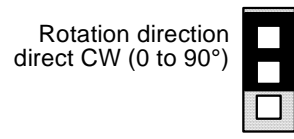

Stroke adjustment

To adjust the stroke, move the adjustment screws at the desired position.